

DL225 Series

Square Coaxial Lights

Product Datasheet



Multiple Control Options

As with many Ai lighting products, cable inline and external controllers are available

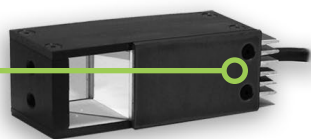

Diffuse On-axis Illumination

High Intensity LEDs create a directed sheet of light on surfaces, suitable for area scan camera inspections



M6 Mounting Points

Engineered with multiple M6 mounting points on the end for highly adjustable positioning



High Power LEDs

Equipped with industrial grade LEDs capable of high output strobe and continuous operation, all while maintaining a long lifespan



DL225 Series Description

With flexibility in mind, the DL225 Series of square on-axis illuminators are engineered to provide class-leading intensity on target in a variety of sizes and available wavelengths.

The combination of extensive thermal modeling, a high-efficiency heat sinking system, and the inclusion of high-performance optical components, optimizes light output while still protecting the LEDs.

The DL225 differs from the DL110 in being designed for use with area scan camera applications, such as wafer surface inspection or others where differential reflection from a target is required.



High Intensity



13 Available Wavelengths



Multiple Control Options



1-2 Week BTO Lead Times

General Information

General Specifications

Category	Specification	Detail			
Optical	Available Wavelengths	White, 365 nm, 375 nm, 385 nm, 395 nm, 405 nm, 455 nm, 470 nm, 530 nm, 590 nm, 625 nm, 850 nm, 940 nm			
	Available Lensing	No Lenses			
	Available Light Conditioning	None			
Electrical	Power Consumption Info	See Power Requirements on Page 10			
	Cable Info	80" -0/+6" Long (2 m -0/+150 mm), 105 °C Rated, Foil Shield w/ Drain			
Mechanical	Sizing Info	Standard	Length	4.17"(105.8mm) to 9.11"(231.3mm)	See Page 7 for More Details
		Width	1.41"(35.7mm) to 6.44"(163.4mm)		
		Height	1.31" (33.3mm) to 6.35"(161.3mm)		
	Weight Info (Standard)		~ 0.35 lbs (~158 g) per DL225-025 Unit, ~ 0.70 lbs (~317 g) per DL225-050 Unit, ~ 1.89 lbs (~857 g) per DL225-075 Unit, ~ 3.06 lbs (~1388 g) per DL225-100 Unit, ~ 6.38 lbs (~2894 g) per DL225-150 Unit		
	Mounting Info	M6 Mounting Holes			
	Material Info	Anodized Aluminum Housing, Acrylic Window, Glass Beam Splitter, Nickel Plated Brass, PVC Cable Jacket, Steek Black Oxide Fasteners			
Thermal	Operating Case Temperatures	25 °C to 60 °C			
	Operating Ambient Temperatures	0 °C to 35 °C			
Certification	Compliance	CE, RoHS, IEC 62471			
	IP Rating	IP50			
	Lumen Maintenance - White Only	L70 (50,000 Hours)			

General Information - Continued

Part Number Key

Model	-	Emitting Length and Width (mm)	Peak Wavelength	Connector/Control	-	Alternative Connector
DL225	-	XXX	XXX	XX	-	XXX
DL225		025	365 (UV)	C1		M8 ¹
		050	375 (UV)	C5		M12 ¹
		075	385 (UV)	IC		
		100	395 (UV)	I3		
		150	405 (violet)	I3S		
			455 (royal blue)	24		
			470 (blue)			
			530 (green)			
			590 (amber)			
			625 (red)			
			850 (IR)			
			940 (IR)			
			WHI (white)			
more info on page		7	5	11		12

Example Part Numbers:

DL225-050470C1
DL225-150WHIIC-M12

¹Available with 24, IC, I3, and I3S options only

In Stock

Lead Times

DL225-050WHIIC
DL225-050625IC

Stock products ship within three days.
Build-to-Order custom products ship within one to two weeks.

Configurator

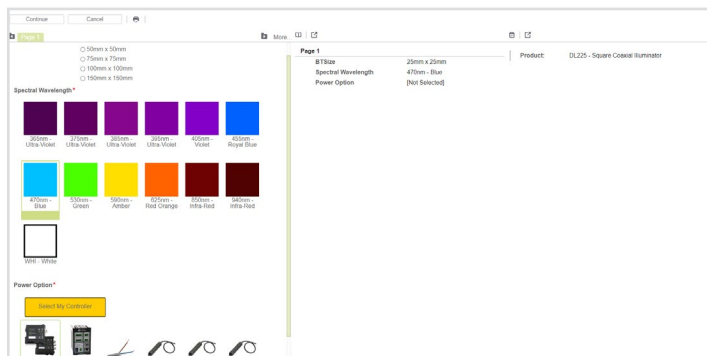

Need a build-to-order custom lighting solution in 2 weeks or less? Advanced Illumination's online configurator helps you tailor our DL225 Square Coaxial Light to your specific needs. For a guided configuration, [visit our online configurator](#).

Optical Information

Intensity Characteristics

Intensity Distribution Image at 25 mm Working Distance

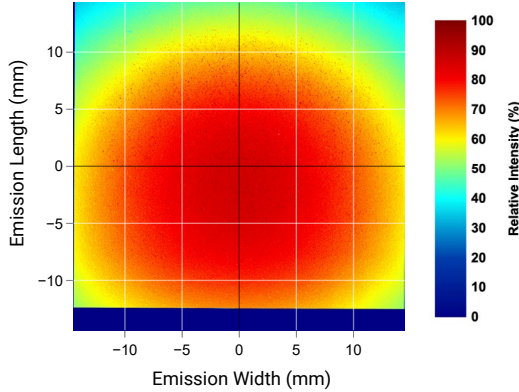

Intensity distribution sample image was taken with a 25 mm white DL225 unit.

Illuminance vs Working Distance

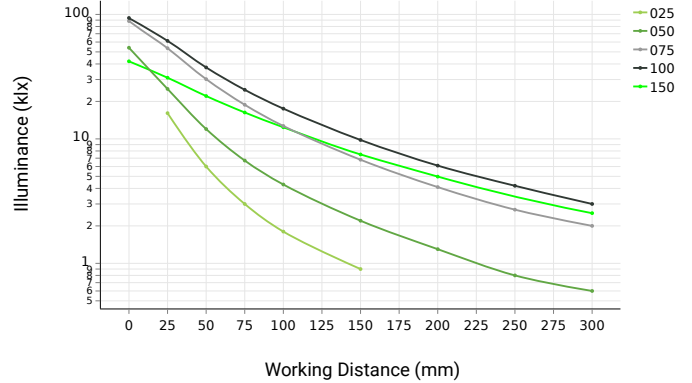

Illuminance data was collected using white DL225 units.

FWHM vs Working Distance

Uniformity

Emission Width FWHM vs Working Distance

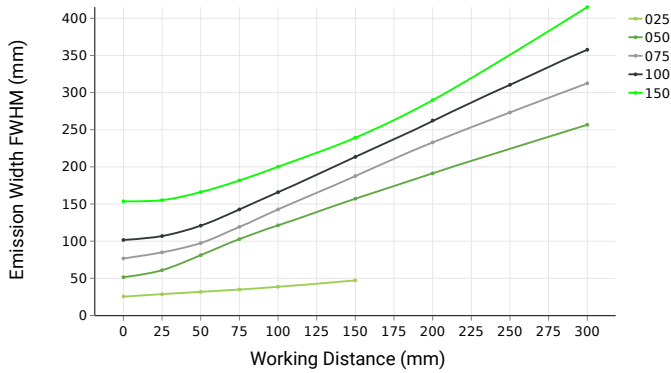

FWHM data was collected using white DL225 units.

Emission Width Profile Plot

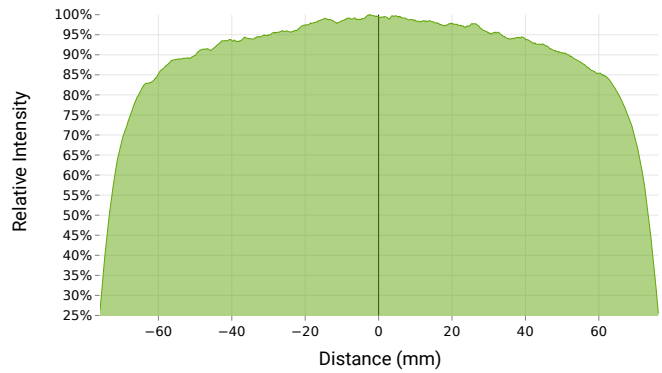

Emission Width Profile Plot sample was taken with a 25 mm white DL225 unit at a 25mm working distance.

Continuous vs Strobe Intensity

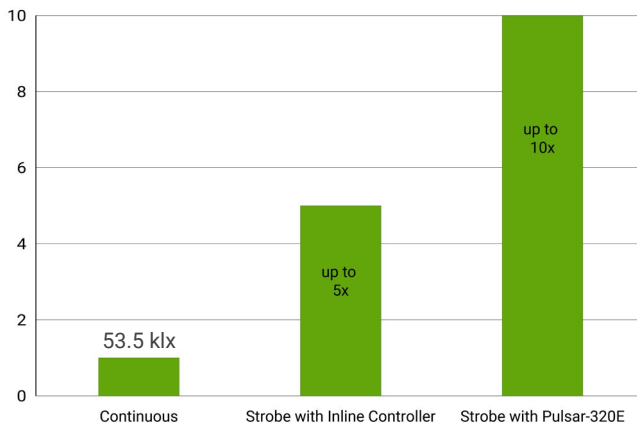

Under continuous operation, a 75 mm white DL225 unit will output an **illuminance of 53.5 klx** and an **irradiance of 183.5 W/m²** at a 25 mm working distance. For applications that require higher output, the DL225 Series has been engineered to be overdrive strobe capable. When configured with Aii's strobe enabled Inline Controller (I3 and I3S), the DL225 is capable of outputting up-to 5X continuous levels. When configured with a C5 connector, compatible with Aii's Pulsar 320E, a **DL225 can be strobed up-to 10X continuous intensity levels.**

Disclaimer: The measurements provided above are for approximations only and may vary depending on the method of measurement and the specific configuration being measured.

Optical Information - Continued

White Spectral Profile

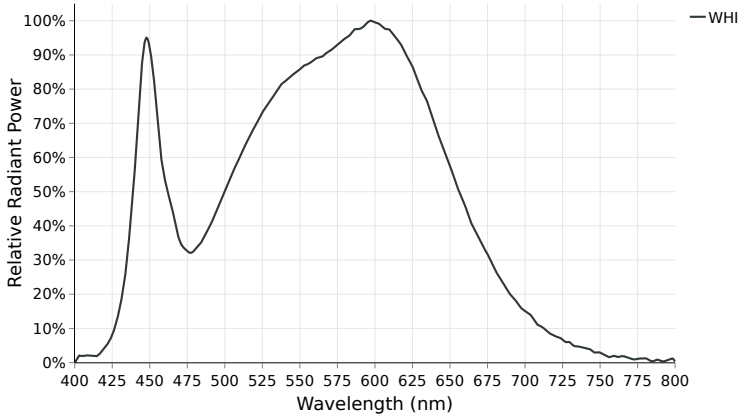

White LED illumination is the most commonly used machine vision lighting configuration. It is often the default choice when specific features of interest do not require color-based highlighting. However, [white LEDs can vary in color temperature, which can impact machine vision systems](#), specifically when matching white light sources.

The DL225 Series white LEDs have a relatively neutral color correlated temperature (CCT) of **5500 K**.

For a more detailed look at the white spectral data, download the [csv file of the raw spectral values](#) and refer to our [Product Spectra Distribution Charts PDF](#).

Visible Spectral Profiles

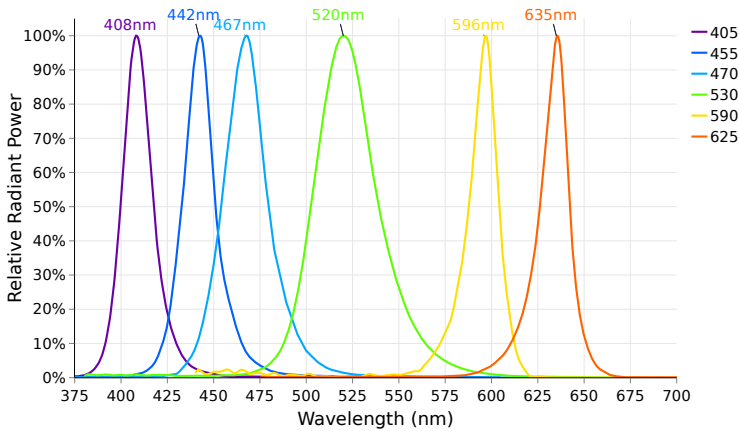

Visible color illumination consists of using wavelengths between 400-700 nm to either create or eliminate contrast on an inspection subject based on differences in a features color hue. When referring to a color wheel, simply remember the following: like colors reflect and brighten surfaces; conversely, opposing colors absorb and darken surfaces.

The DL225 Series is available in **405 nm, 455 nm, 470 nm, 530 nm, 590 nm, and 625 nm** configurations.

For a more detailed look at the visible color spectral data, download the [csv file of the raw spectral values](#) and refer to our [Product Spectra Distribution Charts PDF](#).

Non-Visible Spectral Profiles

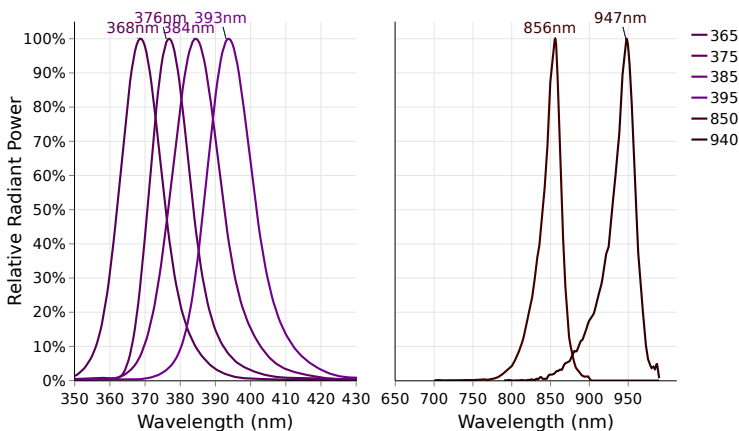

Coaxial lights with UVA/NIR blend shadowless, on-axis illumination ideal for flat/reflective surfaces with specialized spectral uses. Coaxial UVA (315-400nm) ensures perfectly uniform fluorescence excitation for inspecting security features, semiconductor contaminants & coating integrity. Coaxial NIR (700-1000nm) provides clear subsurface viewing through silicon wafers & PCB coatings or analyzing multi-layer films without shadows.

The DL225 Series is available in **365 nm, 375 nm, 385 nm, 395 nm, 850 nm, and 940 nm** configurations.

For a more detailed look at the NIR spectral data, download the [csv file of the raw spectral values](#) and refer to our [Product Spectra Distribution Charts PDF](#).

Disclaimer: The measurements provided above are for approximations only and may vary depending on the method of measurement and the specific configuration being measured.

Optical Information - Continued

Photobiological Risk Factors

Group	Description	Affected Wavelengths (nm)
Exempt	No Photobiological Hazard	850, 940
Group 1	No Photobiological hazard under normal behavioral limitations	405, 455, 470, 530, 590, 625, WHI
Group 2	Does not pose a hazard due to aversion response to bright light or thermal discomfort	365, 375, 385, 395

Advanced Illumination's lighting products have been tested and classified to IEC standards by accredited testing services. For more information on photobiological risk factors, please view the following PDF: <https://www.advancedillumination.com/wp-content/uploads/2019/04/IEC-040119.pdf>

Cleaning Guidelines



To clean our light's optics, it is best to only clean when necessary. Dusting is always the first step in cleaning your optics. Wiping a dusty optic is like cleaning it with sandpaper. So always dust with a canned air duster or compressed and filtered air before wiping any optic. If the dusted optic has no visible stains after you dust it, then remember: "If it's not dirty, don't clean it." Avoid wiping optics when possible.

If dusting did not clean the lens or the lens has stains, use only de-ionized water and mild dish soap with a low lint cloth designed for optics to avoid damage to the optic by any harsh chemicals.

Polarizers, beam splitters and collimated films should never be wiped with any type of cloth or solvent, only use the air dusting method to clean these types of optics.

The aluminum housing can be wiped down when dusting is not a sufficient means to thoroughly clean.

Mechanical Information

Installation Drawings

DL225-025

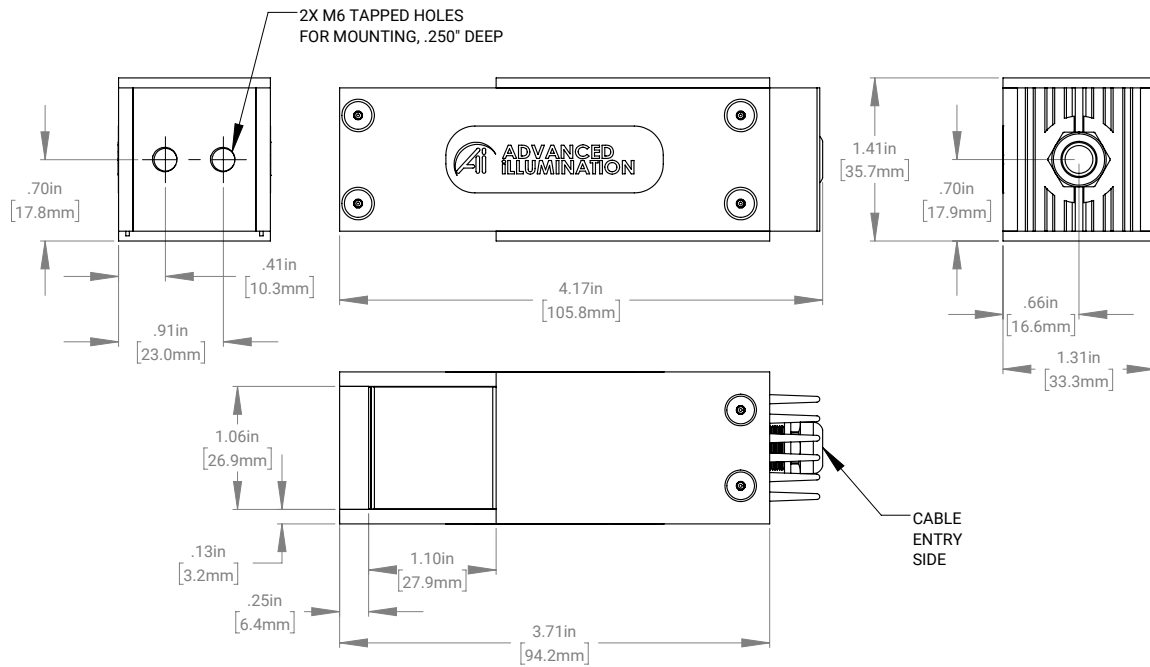

For full installation drawings and complete CAD models of this configuration, please visit the [downloads section of the product webpage](#).

DL225-050

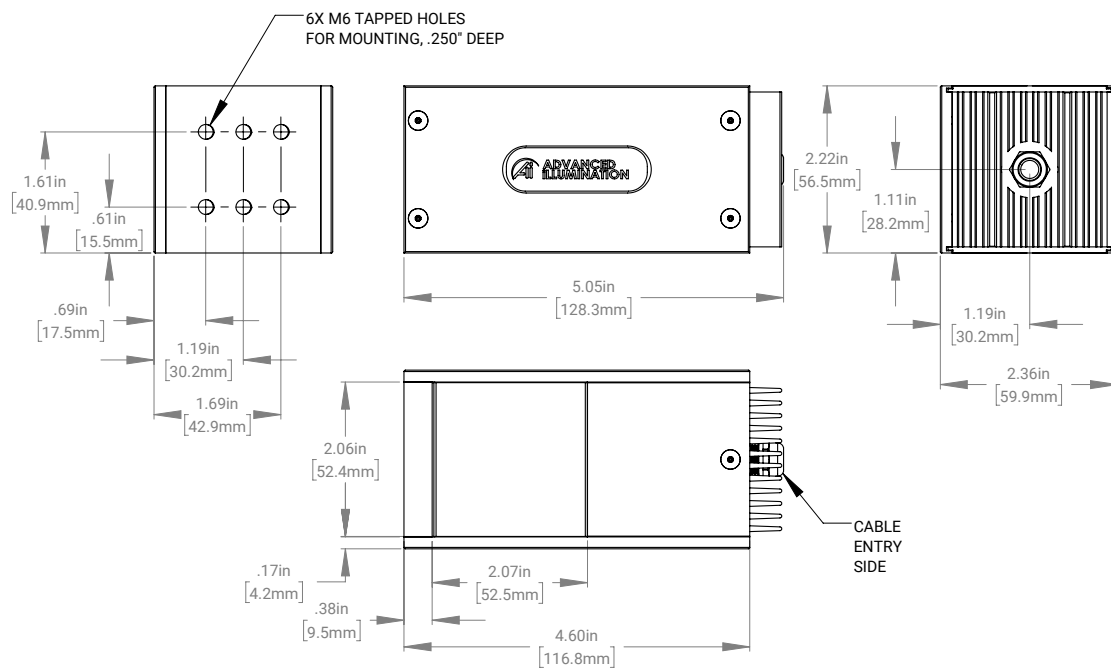

For full installation drawings and complete CAD models of this configuration, please visit the [downloads section of the product webpage](#).

Mechanical Information - Continued

Installation Drawings

DL225-075

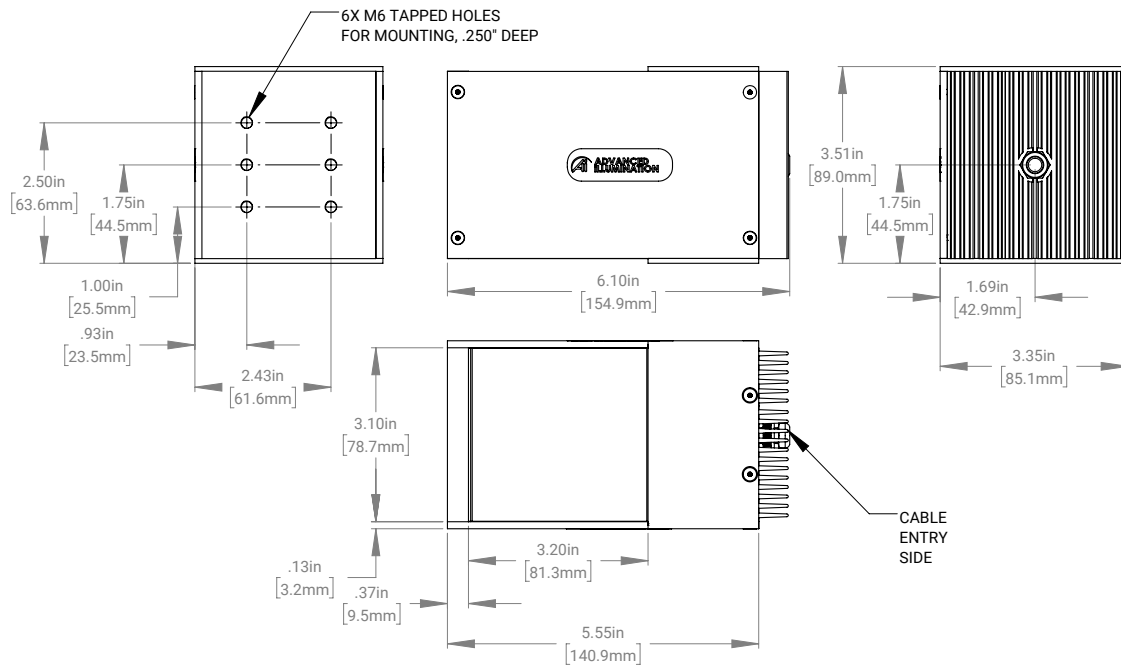

For full installation drawings and complete CAD models of this configuration, please visit the [downloads section of the product webpage](#).

DL225-100

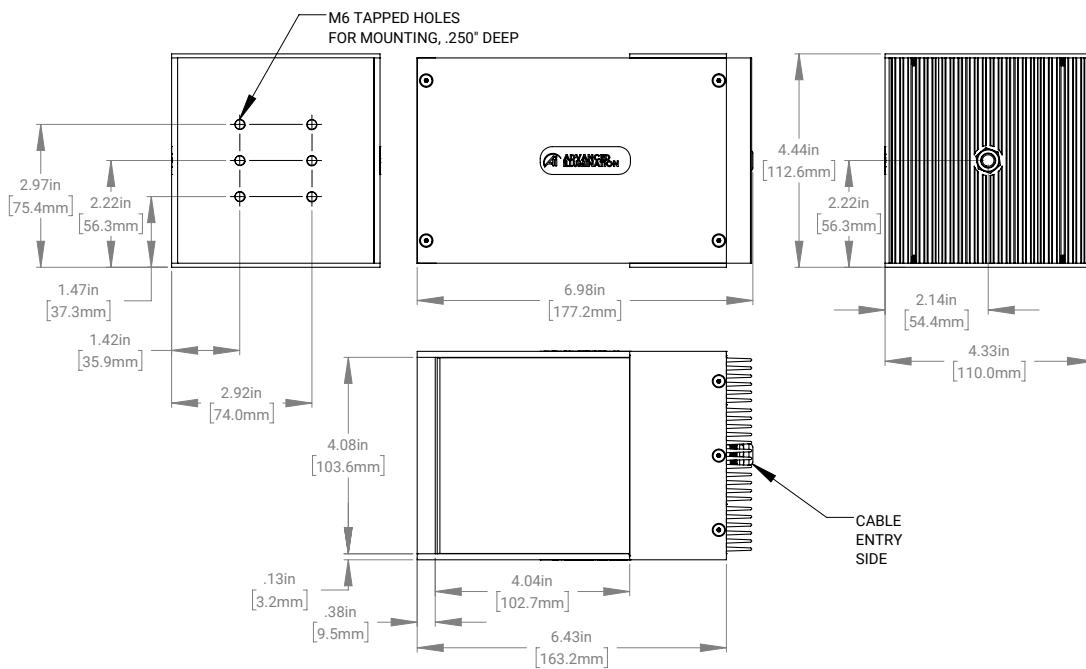

For full installation drawings and complete CAD models of this configuration, please visit the [downloads section of the product webpage](#).

Mechanical Information

Installation Drawings

DL225-150

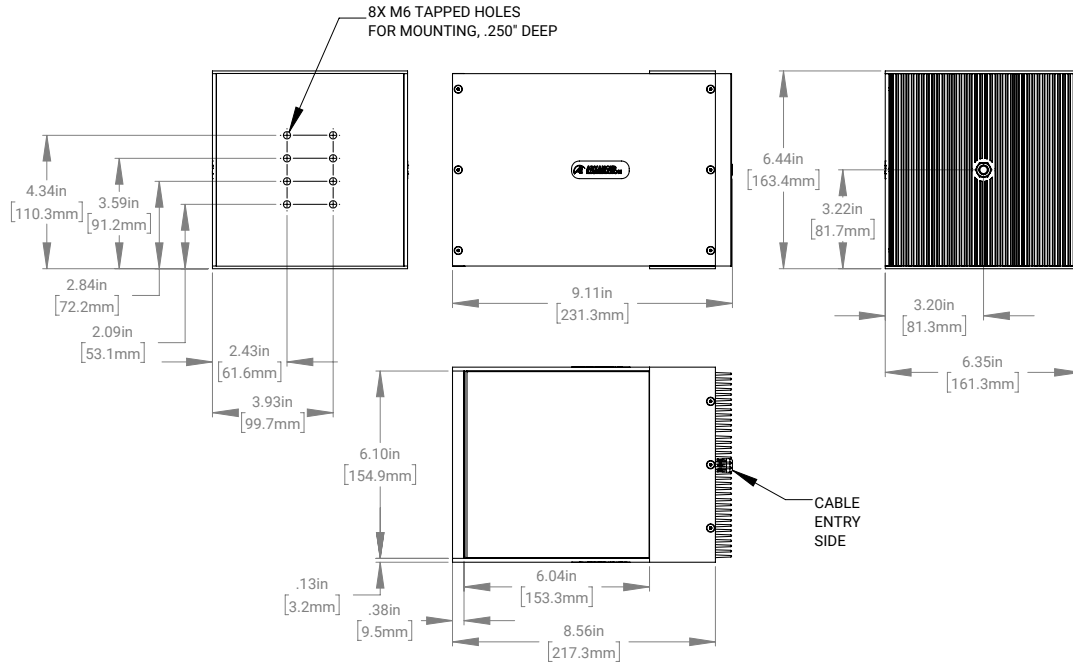

For full installation drawings and complete CAD models of this configuration, please visit the [downloads section of the product webpage](#).

Electrical Information

Power Requirements









Current Required for Power Supply Sizing

Size	Wavelengths	Configured w/ Voltage Drive (24)	Configured w/ Standard Controller (IC, I3, I3S, C1, C5)
025	375, 365, 385, 395, 405	N/A	0.090A
	455, 470, 530, WHI	0.060A	0.150A
	590, 625	0.060A	0.120A
	850, 940	N/A	0.080A
050	375, 365, 385, 395, 405	0.350A	0.240A
	455, 470, 530, WHI	0.240A	0.270A
	590, 625	0.120A	0.240A
	850	N/A	0.220A
	940	0.350A	0.220A
075	375, 365, 385, 395, 405	N/A	0.460A
	455, 470, 530, WHI	0.540A	0.550A
	590, 625	0.540A	0.400A
	850	0.350A	0.550A
100	940	N/A	0.550A
	375, 365, 385, 395, 405	1.400A	0.850A
	455, 470, 530, WHI	0.960A	0.850A
	590, 625	0.480A	0.960A
	850	0.700A	0.800A
150	940	1.400A	0.800A
	375, 365, 385, 395, 405	2.100A	0.850A
	455, 470, 530, WHI	2.160A	1.090A
	590, 625	1.080A	1.090A
	850	1.050A	1.050A
	940	2.100A	1.050A

Note: All Advanced Illumination lights and controllers are nominally powered by 24V DC unless otherwise noted. Strobe overdriving with controller based models may require more current and voltage overhead. The values above do not include background current draw from the controller (~100 mA total).



Electrical Information - Continued

Control Options

Controller Image	Controller Details	Connector Image
	<p>DCS Single Output Controller - Compatible with C1 Configurations PN: DCS-100E</p> <p>The DCS-100E is a compact, din-rail mounted general-purpose external controller with one C1 output connector, wired with three channels. Capable of providing single channel control or multi-channel control for RGB compatible lights.</p> <p>Output Power: 90 W Max Continuous, 540 W Max Pulsed (Overdrive Strobe) Output Current: 4.5A Max Continuous, 15 A Max Pulsed I/Os: 3 External Trigger Inputs Interface: 10/100 Ethernet with Software and browser-based GUIs. SDKs are also available.</p> <p>For more information about our DCS-100E, please visit the controller product page.</p>	
	<p>DCS Triple Output Controller - Compatible with C1 Configurations PN: DCS-103E</p> <p>The DCS-103E is a din-rail mounted general-purpose multi-light controller with three C1 output connectors. Capable of driving three lights in sync or asynchronously.</p> <p>Output Power: 30 W Max Continuous / Output, 180 W Max Pulsed / Output Output Current: 1.5A Max Continuous / Output, 5 A Max Pulsed / Output I/Os: 3 External Trigger Inputs Interface: 10/100 Ethernet with Software and browser-based GUIs. SDKs are also available.</p> <p>For more information about our DCS-103E, please visit the controller product page.</p>	
	<p>Pulsar 320E High Current Controller - Compatible with C5 Configuration PN: Pulsar 320E</p> <p>The Pulsar 320E is a high-power, dual output, pulse-only controller geared for overdriving driving lights at very short flash durations with very high current.</p> <p>Output Power: 2500 W Max Pulsed / Output Output Current: 50 A Max Pulsed / Output I/Os: 2 External Trigger Inputs Interface: 10/100 Ethernet with Software GUI. SDKs are also available.</p> <p>For more information about our Pulsar 320E, please visit the controller product page.</p>	
	<p>Inline Controller - Continuous Only - IC Configurations PN: N/A</p> <p>The IC is an inline, cable-mounted continuous-only controller configured/wired directly for the ordered light head.</p> <p>Output Power: 25 W Max Continuous Output Current: 1.25 A Max Continuous I/O: 1 0-10 V Analog Dimming Input Interface: Direct Cable (flying leads or optional connector)</p> <p>For more information about our IC Controller please visit the controller product page.</p>	

Electrical Information - Continued

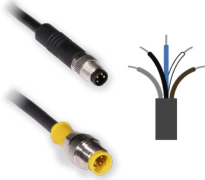
Control Options - Continued

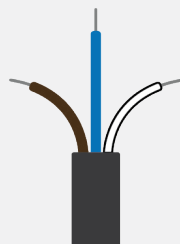
Controller Image	Controller Details	Connector Image
	<p>Inline Controller - Strobe and Continuous - I3 & I3S Configurations PN: N/A</p> <p>The I3 and I3S are inline, cable-mounted continuous and pulse (overdrive strobe) capable controllers configured/wired directly for the ordered light head. When operated in pulsed mode, the I3 is a default-on device on power up, whereas the I3S is default-off, requiring a trigger to illuminate.</p> <p>Output Power: 25 W Max Continuous, 125 W Max Pulsed Output Current: 1.25 A Max Continuous, 8 A Max Pulsed (Load Dependent) I/Os: 1 Gated Trigger Signal, 1 0-10 V Analog Dimming Input Interface: Direct Cable (flying leads or optional connector)</p> <p>For more information about our I3/I3S Controller, please visit the controller product page.</p>	
	<p>24V Driver - Continuous Only - 24 Configurations PN: N/A</p> <p>24V option allows lights to operate continuous output with 24V connection and no additional controllers.</p> <p>Modes: Continuous, can be wired to some 3rd party controllers or external relays for gated operation Interface: Direct cable (flying leads or connector options)</p>	

Inline Control Option Wiring Information

Standard Flying Lead and Optional M12 Connector Pinout Functions

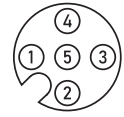
Pin (M12)	Wire Color	24V Functions	IC Functions	I3/I3S Functions	I4 Functions	M12 Pinout
1	BROWN	24V DC	24V DC	24V DC	24 V DC	 5-Position Male Connector
2	WHITE	N/A	0-10V Analog Control	Reserved	NPN/Active Low Trigger	
3	BLUE	DC GND	DC GND	DC GND	DC GND	
4	BLACK	N/A	Gate Low	PNP/Active High Trigger	PNP/Active High Trigger	
5	GRAY	N/A	N/A	0-10V Analog Control	0-10 V Analog Dimming	

The functions above are only applicable when ordering an 24, IC, I3, I3s, or I4 power configuration with our without an M12 connector. For more wiring information pertaining to strobing and dimming functionality, please download the controller manuals and datasheets.

Optional M8 Connector Pinout Functions

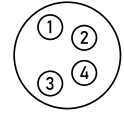
Pin (M8)	Wire Color	24V Functions	IC Functions	I3/I3S Functions	I4 Functions	M8 Pinout
1	BROWN	24V DC	24V DC	24V DC	24 V DC	 4-Position Male Connector
2	WHITE	N/A	0-10V Analog Control	Reserved	Active Low Trigger	
3	BLUE	DC GND	DC GND	DC GND	DC GND	
4	BLACK	N/A	Gate Low	Active High Trigger	Active High Trigger	

The functions above are only applicable when ordering an 24, IC, I3, I3s, or I4 power configuration with our without an M8 connector. For more wiring information pertaining to strobing and dimming functionality, please download the controller manuals and datasheets.

Accessories

Category	Accessory Image	Accessory Detail
Power Supply		<p>24 Volt DC Power Supply PN: PS24-TL</p> <p>This convenient power source is a universal AC input switching power supply with a regulated output DC current. The power supply comes with an LED Power Indicator, tinned leads marked Positive (+) and Negative (-) and 2 WAGO connectors for simplified assembly.</p> <p>For more information about our 24 Volt DC Power Supply, please visit this webpage.</p>
		<p>Manual Dimming Accessory for the IC, I3 and I3s PN: DCS-MP</p> <p>The DCS-MP is a 30-position potentiometer, detented for precision level control and provides repeatable dimming with cable inline controllers. Features include DIN-rail mountable, a flip up cover to prevent accidental adjustments, spring clamp wiring terminal for flying leads or an M12 connector for use with the IC or I3/I3S Inline Controllers.</p> <p>For more information about our Manual Dimming Accessory please visit this webpage.</p>
Dimmer		<p>Manual Dimming Accessory for the IC PN: MP-ICS</p> <p>The MP-ICS is a dimmer which is designed for use on lights with the IC Inline Controller. This unit provides for 0 – 100% intensity control. It is NOT COMPATIBLE with LLI37, BLI38, LLI67, and BLI68 "IC" Lights or lights built with the "24v controller" option.</p> <p>For more information about our Manual Dimming Accessory, please visit this webpage.</p>
Extension Cable		<p>DCS-100E/103E Extension Cable, Single Light Power Cable - C1 Configuration PN: LC-XX-S</p> <p>This extension cable was designed for applications requiring power cables longer than the standard 2 meters provided with Ai lights. This single light cable features a single male and single female 7 pin locking connector (C1) and can be purchased in 3 - 15-meter lengths.</p> <p>For more information about our DCS-100E/103E Extension Cable, Single Output, please visit this webpage.</p>
		<p>DCS-100E/103E Extension Cable, Dual Light Power Cable - C1 Configuration PN: LC-XX-Y</p> <p>This extension cable was designed for applications requiring two identical lights to be powered through a single controller. These Y cables feature a single male and dual female 7 pin locking connectors (C1) and can be purchased in 3 - 15-meter lengths. See attached spec sheet for compatible light configuration.</p> <p>For more information about our DCS-100E/103E Extension Cable, Split Output, please visit this webpage.</p>
Extension Cable		<p>Pulsar 320E Extension Cable - C5 Configuration PN: LC-XX-S-C5</p> <p>This extension cable was designed for applications requiring power cables longer than the standard 2 meters provided with Ai lights. This single light cable features a single male and single female Pulsar 320 connector (C5) and can be purchased in 3 - 15 meter lengths.</p> <p>For more information about our Pulsar 320E Extension Cable, please visit this webpage.</p>
Adaptor Cable		<p>Cognex Gen2 Inline Controller Adaptor Cable PN: AD-I3-CGX2</p> <p>This cable adaptor is for connecting I3/I3S configured lights with Cognex Gen2 Cameras, and comes with a male to female M12 connectors.</p> <p>For more information about our Cognex Gen2 Inline Controller Adaptor Cable, please visit this webpage.</p>

Accessories - Continued

Category	Accessory Image	Accessory Detail
Filters		<p>Camera Lens Band Pass Filters PN: BPXXX-YYY</p> <p>Eliminating all but a narrow band of light (+/- 40nm) centered on the specified wavelength, band pass filters are used to enhance colors, or to stop unwanted ambient light from reaching the camera. Filtering can replace existing shrouds, simplifying the physical set up of an inspection site. Ai offers 635nm and 660nm band pass filters to fit several different lens sizes.</p> <p>For more information about our Camera Lens Band Pass Filters, please visit this webpage.</p>

Additional Information

Warranty

Every Advanced illumination, Inc. (Ai) product is thoroughly inspected and tested before leaving the factory. Products are warranted to be free of defects in workmanship and materials for a period of FIVE YEARS from the original date of purchase. Should a defect develop during this period, customers may return the complete product, freight prepaid, to one of Ai's distributors or to the Ai factory. All product warranty returns require a Return Merchandise Authorization (RMA) number which is obtained from Customer Service. The RMA number must be clearly marked on the outside of the package. Ai will inspect the unit, and if a defect is found will, at our option, repair or replace the product without charge. Ai disclaims liability for any implied warranties, including implied warranties of "merchantability" and "fitness for a specific purpose." For products under warranty that have since been discontinued, Ai will make an effort to replace with equivalent parts; for circumstances that do not allow for equivalent replacement, Ai reserves the right to repair or replace these products with an updated version. Ai cannot be held responsible for the unauthorized or inappropriate use of its products. Any unauthorized repair or modifications will result in a voided warranty. No Liability for Consequential Damages: In no event shall Ai be liable for any consequential, special, incidental, or indirect damages of any kind arising from the sale or use of the products.

Compliance

Our lighting products are designed and tested to meet CE, RoHS, and IEC standards. As a global ISO 9001 certified company, we understand the importance of compliance and perform accelerated testing on every product before shipment. For more information on our compliance standards, please see our compliance documentation here: <https://www.advancedillumination.com/services/compliance-statements/>

Electromagnetic Compatibility

This product was tested and complies with the regulatory requirements and limits for electromagnetic compatibility (EMC) as stated in the product specifications. These requirements and limits are designed to provide reasonable protection against harmful interference only when the product is operated in its intended industrial electromagnetic environment. To minimize the potential for electromagnetic interference or unacceptable performance degradation, install and use this product in strict accordance with the instructions in the product documentation.

Customer Service

For information on existing orders, or to make an order adjustment, contact us Monday through Friday 8:00 am to 5:00 pm ET or send an email to orders@advancedillumination.com.

Company Information

Advanced Illumination
440 State Garage Road, Rochester, VT 05767
Phone: +1 (802) 767 3830
Fax: +1 (802) 767 2636
Email: info@advancedillumination.com
Web: advancedillumination.com
© 2023 Advanced illumination Inc. All rights reserved