

AL247 Series

UltraSeal Bar Lights | Product Datasheet



IP69K Certified

Engineered to handle the most extreme washdown environments

High Power LEDs

Equipped with industrial grade LEDs capable of high output strobe and continuous operation, all while maintaining a long lifespan

FDA Compliant Housing

Configurable with either anodized aluminum or 316 stainless steel

Crevice Free Design

Allows for easy cleaning and minimizes the chance of material buildup

***Patented Design**

AL247 Series Description

Engineered for the most demanding washdown applications, the AL247 Series, our UltraSeal™ Bar Light, provides exceptionally rugged illumination. Achieving IP69K certification, conducted by a 3rd party lab, these lights ensure complete protection against dust ingress and high-pressure, high-temperature steam cleaning.

Furthermore, their patented design is virtually crevice-free and features no exposed fasteners, significantly minimizing surfaces where contaminants like food, dust, or debris can collect.

These characteristics make the AL247 UltraSeal™ Bar Lights ideal for hygienic inspection environments, aseptic manufacturing, and food and beverage applications.



IP69K Certified



Crevice Free Design



High Intensity



11 Wavelengths Available



1-2 Week Lead Times Typical

General Information

General Specifications

Certification	Specification	Detail	
Optical	Available Wavelengths	White, 455 nm, 470 nm, 505 nm, 530 nm, 590 nm, 625 nm, 660 nm, 730 nm, 850 nm, 940 nm	
	Available Lensing	Narrow (10°), Medium (25°), Wide (40°)	
	Available Light Conditioning	None	
Electrical	Power Consumption Info	See Power Requirements on Page 9	
	Cable Info	80" -0/+6" Long (2 m -0/+150 mm), 105 °C Rated, Foil Shield w/ Drain	
Mechanical	Sizing Info	Length	8.12" (206.25 mm) to 26.12" (663.45 mm)
		Width	1.69" (42.9 mm)
		Height	0.95" (24.0 mm)
	Weight Info (Standard)	~ 0.92 lbs (~417 g) per 6" Unit Length	
	Mounting Info	M4 Mounting Holes	
	Material Info	Anodized Aluminum or Stainless Steel Housing, Acrylic Window, Stainless Steel Strain Relief, PVC Cable Jacket, 18-8 Stainless Steel Fasteners, Rubberized Epoxy	
Thermal	Operating Case Temperatures	25 °C to 60 °C	
	Operating Ambient Temperatures	0 °C to 35 °C	
Certification	Compliance	CE, RoHS, IEC 62471	
	IP Rating	IP69K	
	Lumen Maintenance - White Only	L70 (50,000 Hours)	

See Page 8 for More Details

General Information - Continued

Part Number Key

Model	Lens Type	-	Emitting Length (in)	Peak Wavelength	Connector/ Control	Housing Material	-	Alternative Connector
AL247	X	-	XX	XXX	XX	XX	-	XXX
AL247	N (Narrow)		06	455 (royal blue)	C1	SS (Stainless Steel)		M8 ¹
	M (Medium)		12	470 (blue)	C5	AL (Anodized Aluminum)		M12 ¹
	W (Wide)		18	505 (cyan)	IC			
			24	530 (green)	I3			
				590 (amber)	I3S			
				625 (red orange)	I4			
				660 (red)	24			
				730 (IR)				
				850 (IR)				
				940 (IR)				
				WHI (white)				
more info on page			8	5	9			11

Example Part Numbers:
AL247N-0645513-M12
AL247M-18WHIC1

Beam Angle (FWHM):
Narrow = 10°
Medium = 25°
Wide = 40°

¹ Available with IC, I3, I3S, I4, and 24 options only

In Stock

Lead Times

Unavailable

Stock products ship within three days.
Build-to-Order custom products ship within one to two weeks (typical).

Configurator

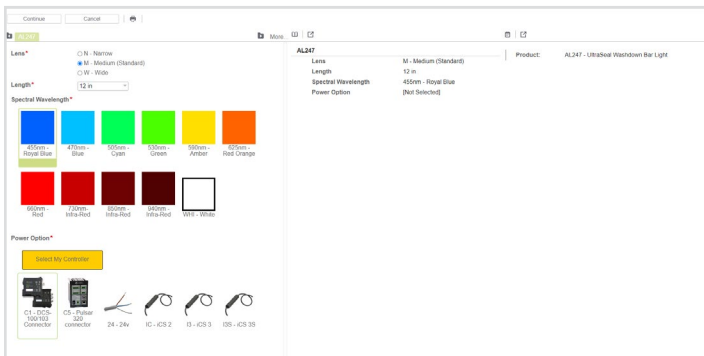

Need a build-to-order custom lighting solution in 2 weeks or less? Advanced Illumination's online configurator helps you tailor our AL247 UltraSeal Bar Light Series to your specific needs. For a guided configuration, [visit our online configurator](#).

Optical Information

Intensity Characteristics

Intensity Distribution at 100 mm Working Distance

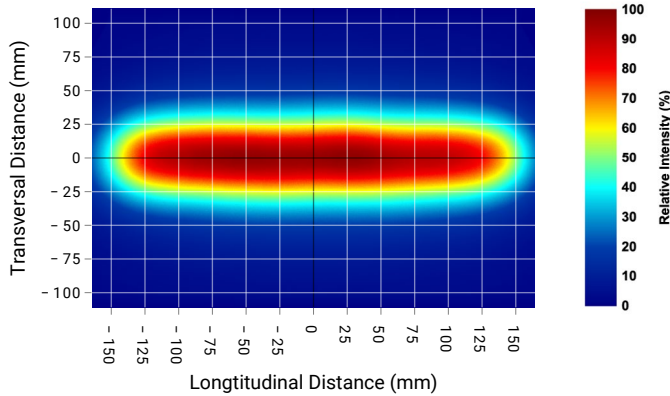

Intensity distribution sample image above taken with a 12-inch white medium lensed AL247 unit.

Illuminance vs Working Distance

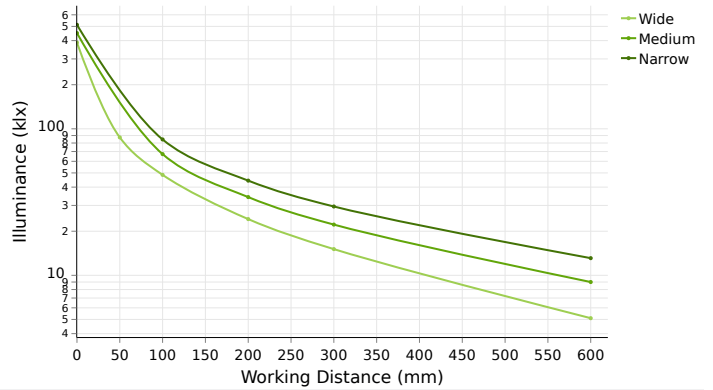

Data shown above have been collected using a 12-inch white AL247 unit.

FWHM vs Working Distance

Transversal FWHM vs Working Distance

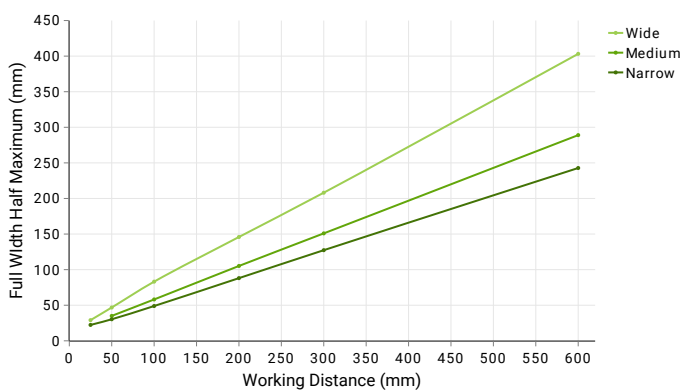

Longitudinal FWHM vs Working Distance

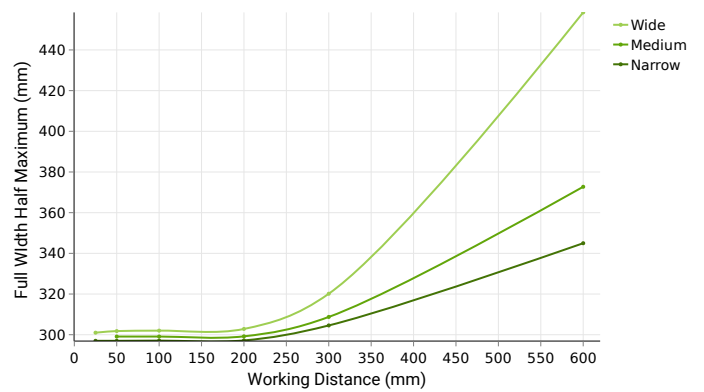

Both Full Width Half Maximum (FWHM) vs Working Distance plots shown above have been measured using a 12-inch white AL247 unit.

Continuous vs Pulsed Intensity

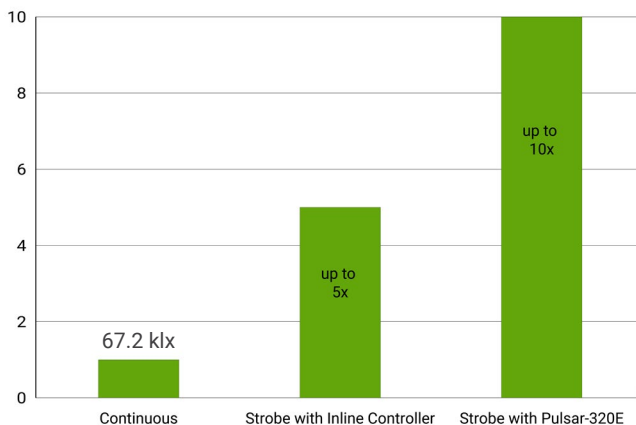

Under continuous operation, a 12-inch white medium lensed AL247 unit will output an **illuminance of 67 klx** and an **irradiance of 218 W/m²** at a 100 mm working distance. For applications that require higher output, the AL247 Series has been engineered to be overdrive strobe capable. When configured with AI's strobe enabled Inline Controller (I3, I3S, and I4), the AL247 is capable of outputting up-to 5X continuous levels. When configured with a C5 connector, compatible with AI's Pulsar 320E, an **AL247 can be strobed up-to 10X continuous intensity levels.**

Disclaimer: The measurements provided above are for approximations only and may vary depending on the method of measurement and the specific configuration being measured.

Optical Information - Continued

White Spectral Profile

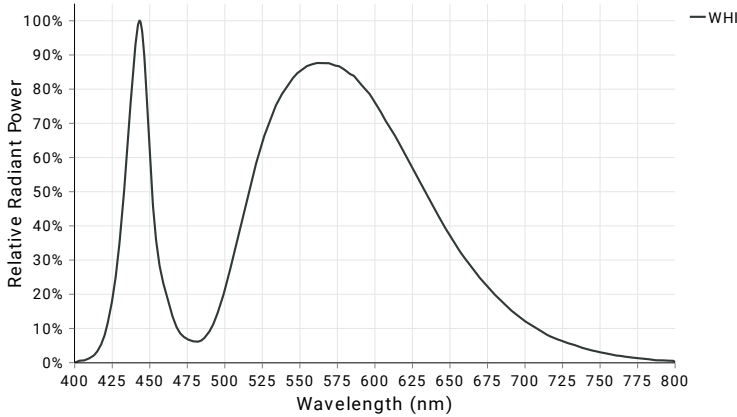

White LED illumination is the most commonly used machine vision lighting configuration. It is often the default choice when specific features of interest do not require color-based highlighting. However, [white LEDs can vary in color temperature, which can impact machine vision systems](#), specifically when matching white light sources.

The AL247 Series white LEDs have a relatively neutral color correlated temperature (CCT) of **5500k**.

For a more detailed look at the white spectral data, download the [csv file of the raw spectral values](#) and refer to our [Product Spectra Distribution Charts PDF](#).

Visible Spectral Profiles

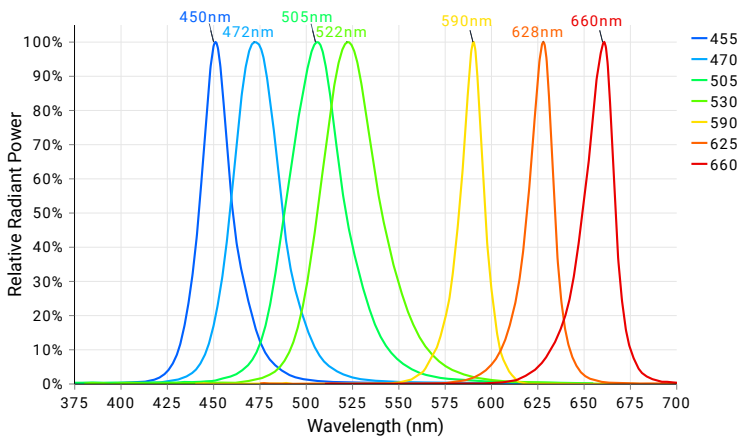

Visible color illumination consists of using wavelengths between 400-700 nm to either create or eliminate contrast on an inspection subject based on differences in a features color hue. When referring to a color wheel, simply remember the following; like colors reflect and brighten surfaces; conversely, opposing colors absorb and darken surfaces.

The A325 is available in **455 nm, 470 nm, 505 nm, 530 nm, 590nm, 625 nm, and 660 nm** visible color configurations.

For a more detailed look at the visible color spectral data, download the [csv file of the raw spectral values](#) and refer to our [Product Spectra Distribution Charts PDF](#).

Non-Visible Spectral Profiles

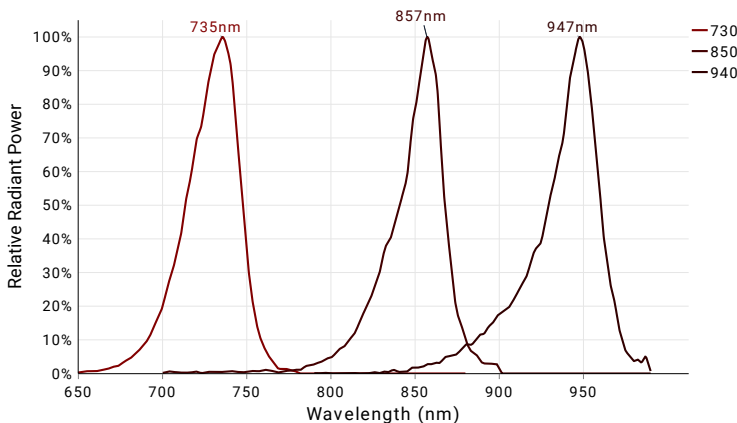

Near-infrared (NIR) imaging is a machine vision techniques that utilize wavelengths outside the visible spectrum. NIR light, with wavelengths between 700-1000 nm, can penetrate certain materials opaque to visible light, making it ideal for certian food safety inspections and medical imaging.

The AL247 Series is available in **730 nm, 850 nm, and 940 nm** configurations.

For a more detailed look at the NIR spectral data, download the [csv file of the raw spectral values](#) and refer to our [Product Spectra Distribution Charts PDF](#).

Disclaimer: The measurements provided above are for approximations only and may vary depending on the method of measurement and the specific configuration being measured.

Optical Information - Continued

Photobiological Risk Factors

Group	Description	Affected Wavelengths
Exempt	No Photobiological Hazard	730 nm, 850 nm, 940nm
Group 1	No Photobiological hazard under normal behavioral limitations	455 nm, 470 nm, 505 nm, 530 nm, 590 nm, 625 nm, 660 nm, 730 nm, WHI
Group 2	Does not pose a hazard due to aversion response to bright light or thermal discomfort	N/A

Advanced Illumination’s lighting products have been tested and classified to IEC standards by accredited testing services. For more information on photobiological risk factors, please view the following PDF: <https://www.advancedillumination.com/wp-content/uploads/2019/04/IEC-040119.pdf>

Cleaning Guidelines



To clean our light’s optics, it is best to only clean when necessary. Dusting is always the first step in cleaning your optics. Wiping a dusty optic is like cleaning it with sandpaper. So always dust with a canned air duster or compressed and filtered air before wiping any optic. If the dusted optic has no visible stains after you dust it, then remember: “If it’s not dirty, don’t clean it.” Avoid wiping optics when possible.

If dusting did not clean the lens or the lens has stains, use only de-ionized water and mild dish soap with a low lint cloth designed for optics to avoid damage to the optic by any harsh chemicals.

Polarizers, beam splitters and collimated films should never be wiped with any type of cloth or solvent, only use the air dusting method to clean these types of optics.

The aluminum housing can be wiped down when dusting is not a sufficient means to thoroughly clean.

Bar Light Comparison Matrix

Not finding the optical specifications you are looking for with the AL247 Series? Refer to the bar light comparison matrix below to compare and contrast Advanced Illumination's comprehensive product offering:

Attributes	AL325					AL295		LL174		
Lens Type	Narrow (N)	Medium (M)	Wide (W)	Extra Wide (Z)	Elliptical (E)	Medium (M)	Wide (W)	Narrow (N)	Medium (M)	Wide (W)
Beam Angle	14°	25°	36°	55°	45° + 15°	20°	32°	10°	25°	40°
Beam Direction	Normal or Oblique					Normal		Normal		
Intensity at 100 mm WD	163 klx	134 klx	110 klx	80 klx	TBD	88 klx	65 klx	75 klx	57 klx	45 klx
	456 W/m ²	427 W/m ²	352 W/m ²	254 W/m ²	TBD	288 W/m ²	208 W/m ²	250 W/m ²	187 W/m ²	146 W/m ²
Transversal FWHM at 600 mm WD	8.54 in (217 mm)	11.73 in (298 mm)	14.25 in (362 mm)	17.12 in (450 mm)	TBD	12.79 in (325 mm)	15.12 in (384 mm)	9.06 in (230 mm)	13.90 in (353 mm)	16.06 in (408 mm)
Longitudinal FWHM at 600 mm WD	12.05 in (306 mm)	14.25 in (362 mm)	16.34 in (415 mm)	19.45 in (494 mm)	TBD	15.95 in (405 mm)	17.72 in (450 mm)	13.50 in (343 mm)	16.69 in (424 mm)	18.35 in (466 mm)
Minimum Working Distance	3.94 in (100 mm)	3.94 in (100 mm)	3.94 in (100 mm)	1.97 in (50 mm)	TBD	0.98 in (25 mm)	0.79 in (20 mm)	3.94 in (100 mm)	1.97 in (50 mm)	1.46 in (37 mm)
Light Width	1.57 in (39.8 mm)					0.79 in (20.0 mm)		1.33 in (33.8 mm)		
Light Height	1.78 in (45.2 mm)					0.79 in (20.1 mm)		1.12 in (28.4 mm)		
Longest Emitting Window Length	84.28 in (2140 mm)					41.61 in (1057 mm)		96.72 in (2457 mm)		
Sizes Available	14	14	14	14	14	14	14	16	16	16
Visible Wavelengths Available	9	9	9	8	8	9	8	8	9	8
UV Wavelengths Available	4	4	4	0	0	4	0	0	4	0
IR Wavelengths Available	3	3	3	3	3	3	3	3	3	3
Polarization Available	Yes	Yes	Yes	Yes	Yes	No	No	Yes	Yes	Yes
Diffusion Available	Yes	Yes	Yes	Yes	Yes	Yes	Yes	Yes	Yes	Yes
IP Rating	IP50					IP50		IP50		
Price	\$\$	\$\$	\$\$	\$\$	\$\$	\$\$	\$\$	\$\$	\$\$	\$\$

To ensure consistent comparisons, all data presented above is based on 12-inch white LED models unless explicitly stated otherwise. Additionally, all measurements provided above are derived from "standard" configurations, excluding sealed models if available as optional.

If you are still not finding the optical specifications needed for your application, [inquire](#) about our semi-custom and full-custom capabilities.

Disclaimer: The measurements provided above are for approximations only and may vary depending on the method of measurement and the specific configuration being measured.

Bar Light Comparison Matrix - Continued

Refer to the continued bar light comparison matrix below to compare and contrast Advanced Illumination's product offering:

Attributes	AL247			AL116	AL126	AL150
Lens Type	Narrow (N)	Medium (M)	Wide (W)	No Lenses	No Lenses	Aimed
Beam Angle	10°	25°	40°	70°	60°	N/A
Beam Direction	Normal			Normal	Normal	Oblique
Intensity at 100 mm WD	84 klx	67 klx	48 klx	32 klx	14 klx	2.2 klx
	277 W/m ²	218 W/m ²	155 W/m ²	110 W/m ²	48 W/m ²	8.5 W/m ²
Transversal FWHM at 600 mm WD	9.57 in (243 mm)	11.38 in (289 mm)	15.87 in (403 mm)	31.54 in (801 mm)	23.31 in (592 mm)	N/A
Longitudinal FWHM at 600 mm WD	13.58 in (345 mm)	14.65 in (372 mm)	18.03 in (458 mm)	46.34 in (1177 mm)	31.26 in (794 mm)	N/A
Minimum Working Distance	3.94 in (100 mm)	1.97 in (50 mm)	1.46 in (37 mm)	0.47 in (12 mm)	0.47 in (12 mm)	0.47 in (12 mm)
Light Width	1.69 in (42.9 mm)			0.79 in (20 mm)	1.27 in (32 mm)	1.33 in (34 mm)
Light Height	0.95 in (24.0 mm)			0.79 in (20 mm)	0.79 in (20 mm)	1.12 in (28 mm)
Longest Emitting Window Length	24 in (610 mm)			20.27 in (515 mm)	41.42 in (1052 mm)	82.12 in (2086 mm)
Sizes Available	4	4	4	10	20	80
Visible Wavelengths Available	8	8	8	8	8	4
UV Wavelengths Available	0	0	0	4	4	1
IR Wavelengths Available	3	3	3	2	2	1
Polarization Available	No	No	No	Yes	Yes	Yes
Diffusion Available	No	No	No	Yes	Yes	Yes
IP Rating	IP69K			IP50	IP50	IP50
Price	\$\$\$	\$\$\$	\$\$\$	\$\$	\$	\$\$\$\$

To ensure consistent comparisons, all data presented above is based on 12-inch white LED models unless explicitly stated otherwise. Additionally, all measurements provided above are derived from "standard" configurations, excluding sealed models if available as optional.

If you are still not finding the optical specifications needed for your application, [inquire](#) about our semi-custom and full-custom capabilities.

Disclaimer: The measurements provided above are for approximations only and may vary depending on the method of measurement and the specific configuration being measured.

Bar Light Comparison Matrix - Definitions

For definitions on the terminology used on the previous page, please refer to the table below:

Definitions	
Beam Angle	FWHM (Full Width Half Maximum)

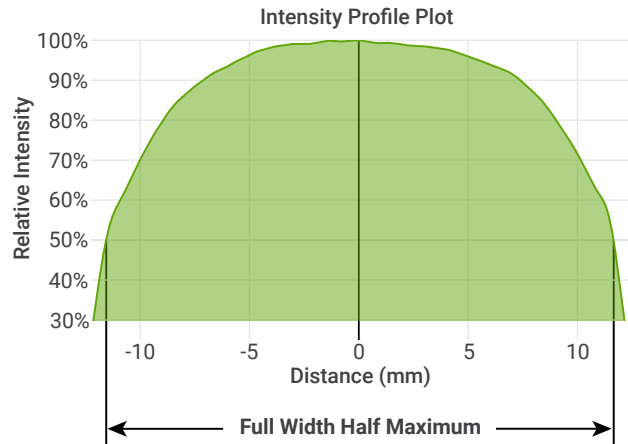
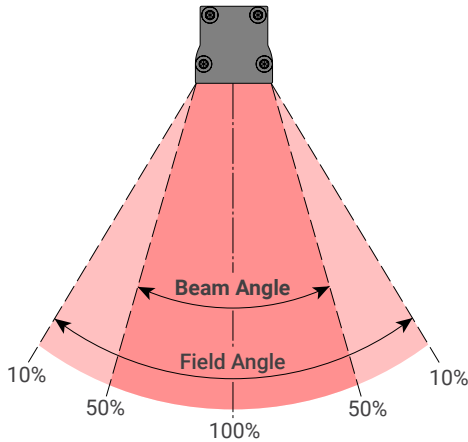

Beam Angle defines the spread of usable light from a projected machine vision light source. It's the angle where the intensity drops to 50% of its peak (FWHM). Beam angle dictates the concentrated, higher-intensity portion of the Field of View (FOV). Field angle is wider, encompassing the total spread of light down to 10% of peak intensity.

FWHM (Full Width Half Maximum) is a measure of the width of a light source's intensity distribution. Specifically, it defines the distance between the points on the intensity profile where the light intensity drops to 50% of its peak value. This FWHM distance is often used to determine the usable FOV (Field of View) when aiming a light at a surface for inspection.

Beam Direction	Longitudinal vs Transversal
----------------	-----------------------------

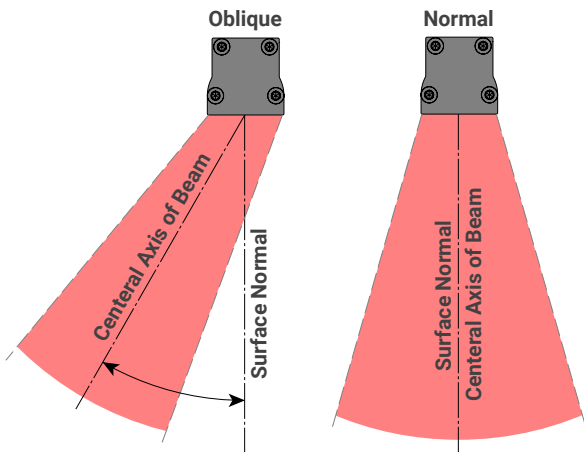

A normal beam direction refers to light emitted perpendicular to the light source's emitting surface, in which the central optical axis is co-linear to the surface normal of the emitting window. An oblique beam direction describes light emitted at an angle relative to the light source's surface normal. Oblique sources can be useful when imaging specular surfaces, depending on system geometry.

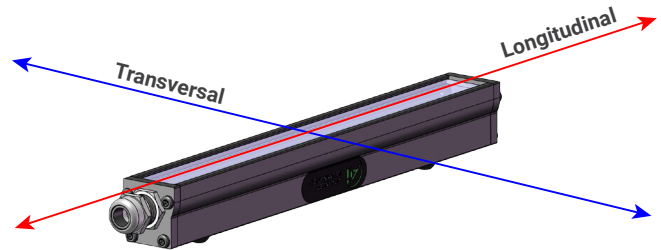

The longitudinal direction refers to the direction that runs parallel to the long axis of the light source. This is typically the longest dimension of the light source housing or emitting surface.

The transversal direction, in contrast, refers to any direction that is perpendicular to the longitudinal direction. It essentially describes any direction that "cuts across" the long axis of the light source.

Disclaimer: The measurements provided above are for approximations only and may vary depending on the method of measurement and the specific configuration being measured.

Mechanical Information

Installation Drawings

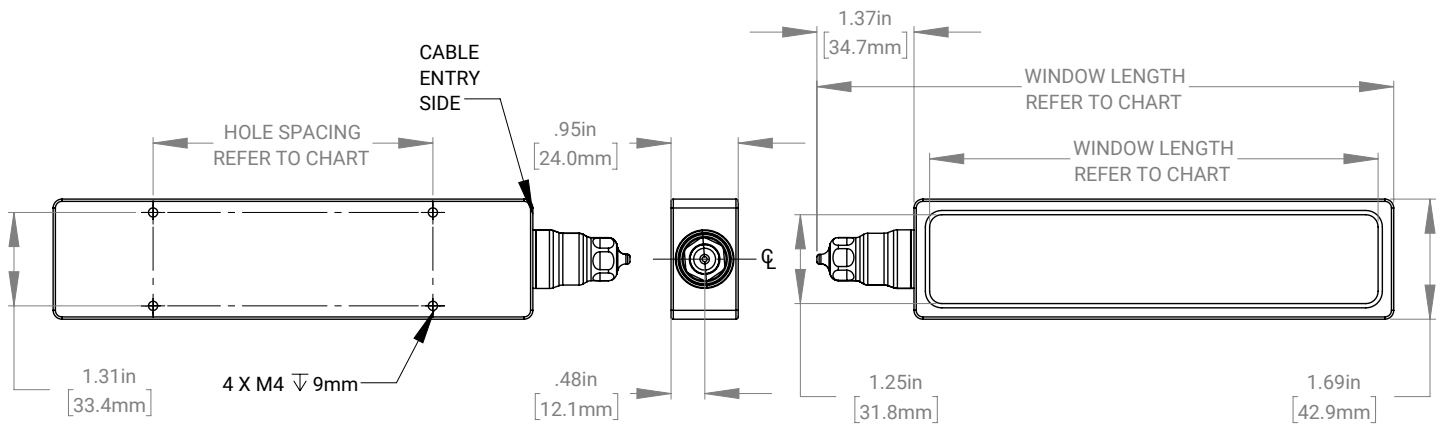

For full installation drawings and complete CAD models of this configuration, please visit the [downloads section of the product webpage](#).

Sizing Chart

Part Number	Length (Inches)		Length (Millimeters)	
	Unit	Window	Unit	Window
AL247-06	8.12	6	206.25	152.4
AL247-12	14.12	12	358.65	304.8
AL247-18	20.12	18	511.05	457.2
AL247-24	26.12	24	663.45	609.6







Power Requirements

Current Required for Power Supply Sizing

Wavelengths	Configured w/ Voltage Drive (24)	Configured w/ Standard Controller (IC, I3, I3S, I4, C1, C5)
WHI, 455 nm, 470 nm, 505 nm, 530 nm	0.062A per linear inch	0.068A per linear inch
625 nm, 660 nm, 730 nm, 850 nm, 940 nm	0.064A per linear inch	0.068A per linear inch







Note: All Advanced Illumination lights and controllers are nominally powered by 24V DC unless otherwise noted. Strobe overdriving with controller based models may require more current and voltage overhead. The values above do not include background current draw from the controller (~100 mA total).

Control Options

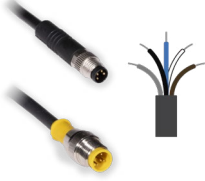
Controller Image	Controller Details	Connector Image
	<p>DCS Single Output Controller - Compatible with C1 Configurations PN: DCS-100E</p> <p>The DCS-100E is a compact, din-rail mounted general-purpose external controller with one C1 output connector, wired with three channels. Capable of providing single channel control or multi-channel control for RGB compatible lights.</p> <p>Output Power: 90 W Max Continuous, 540 W Max Pulsed (Overdrive Strobe) Output Current: 4.5A Max Continuous, 15 A Max Pulsed I/Os: 3 External Trigger Inputs Interface: 10/100 Ethernet with Software and browser-based GUIs. SDKs are also available.</p> <p>For more information about our DCS-100E, please visit the controller product page.</p>	
	<p>DCS Triple Output Controller - Compatible with C1 Configurations PN: DCS-103E</p> <p>The DCS-103E is a din-rail mounted general-purpose multi-light controller with three C1 output connectors. Capable of driving three lights in sync or asynchronously.</p> <p>Output Power: 30 W Max Continuous / Output, 180 W Max Pulsed / Output Output Current: 1.5A Max Continuous / Output, 5 A Max Pulsed / Output I/Os: 3 External Trigger Inputs Interface: 10/100 Ethernet with Software and browser-based GUIs. SDKs are also available.</p> <p>For more information about our DCS-103E, please visit the controller product page.</p>	
	<p>Pulsar 320E High Current Controller - Compatible with C5 Configuration PN: Pulsar 320E</p> <p>The Pulsar 320E is a high-power, dual output, pulse-only controller geared for overdriving driving lights at very short flash durations with very high current.</p> <p>Output Power: 2500 W Max Pulsed / Output Output Current: 50 A Max Pulsed / Output I/Os: 2 External Trigger Inputs Interface: 10/100 Ethernet with Software GUI. SDKs are also available.</p> <p>For more information about our Pulsar 320E, please visit the controller product page.</p>	

Electrical Information - Continued

Control Options - Continued

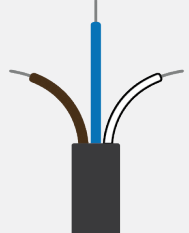
Controller Image	Controller Details	Connector Image
	<p>Inline Controller - Continuous Only - IC Configurations <i>PN: N/A</i></p> <p>The IC is an inline, cable-mounted continuous-only controller configured/wired directly for the ordered light head.</p> <p>Output Power: 25 W Max Continuous Output Current: 1.25 A Max Continuous I/O: 1 0-10 V Analog Dimming Input Interface: Direct Cable (flying leads or optional connector)</p> <p>For more information about our IC Controller please visit the controller product page.</p>	
	<p>Inline Controller - Strobe and Continuous - I3 & I3S Configurations <i>PN: N/A</i></p> <p>The I3 and I3S are inline, cable-mounted continuous and pulse (overdrive strobe) capable controllers configured/wired directly for the ordered light head. When operated in pulsed mode, the I3 is a default-on device on power up, whereas the I3S is default-off, requiring a trigger to illuminate.</p> <p>Output Power: 25 W Max Continuous, 125 W Max Pulsed Output Current: 1.25 A Max Continuous, 8 A Max Pulsed (Load Dependent) I/Os: 1 Gated Trigger Signal, 1 0-10 V Analog Dimming Input Interface: Direct Cable (flying leads or optional connector)</p> <p>For more information about our I3/I3S Controller, please visit the controller product page.</p>	
	<p>Inline Controller - Strobe and Continuous - I4 Configurations <i>PN: N/A</i></p> <p>The I4 is an inline, cable-mounted continuous and pulse (overdrive strobe) capable controller configured/wired directly for the ordered light head. The I4 can either be operated with a PNP or NPN trigger signal and is IP68 rated.</p> <p>Output Power: 50 W Max Continuous, 150 W Max Pulsed Output Current: 2.1 A Max Continuous, 8 A Max Pulsed (Load Dependent) I/Os: 1 Gated Trigger Signal, 1 0-10 V Analog Dimming Input Interface: Direct Cable (flying leads or optional connector)</p> <p>For more information about our IC Controller please visit the controller product page.</p>	
	<p>24V Driver - Continuous Only - 24 Configurations <i>PN: N/A</i></p> <p>24V option allows lights to operate continuous output with 24V connection and no additional controllers.</p> <p>Modes: Continuous, can be wired to some 3rd party controllers or external relays for gated operation Interface: Direct cable (flying leads or connector options)</p>	

Electrical Information - Continued

Inline Control Option Wiring Information

Standard Flying Lead and Optional M12 Connector Pinout Functions

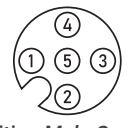
Pin (M12)	Wire Color	24V Functions	IC Functions	I3/I3S Functions	I4 Functions	M12 Pinout
1	BROWN	24V DC	24V DC	24V DC	24 V DC	 <p>5-Position Male Connector</p>
2	WHITE	N/A	0-10V Analog Control	Reserved	NPN/Active Low Trigger	
3	BLUE	DC GND	DC GND	DC GND	DC GND	
4	BLACK	N/A	Gate Low	PNP/Active High Trigger	PNP/Active High Trigger	
5	GRAY	N/A	N/A	0-10V Analog Control	0-10 V Analog Dimming	

The functions above are only applicable when ordering an 24, IC, I3, I3s, or I4 power configuration with our without an M12 connector. For more wiring information pertaining to strobing and dimming functionality, please download the controller manuals and datasheets.

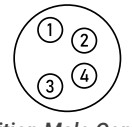

Optional M8 Connector Pinout Functions

Pin (M8)	Wire Color	24V Functions	IC Functions	I3/I3S Functions	I4 Functions	M8 Pinout
1	BROWN	24V DC	24V DC	24V DC	24 V DC	 <p>4-Position Male Connector</p>
2	WHITE	N/A	0-10V Analog Control	Reserved	Active Low Trigger	
3	BLUE	DC GND	DC GND	DC GND	DC GND	
4	BLACK	N/A	Gate Low	Active High Trigger	Active High Trigger	







The functions above are only applicable when ordering an 24, IC, I3, I3s, or I4 power configuration with our without an M8 connector. For more wiring information pertaining to strobing and dimming functionality, please download the controller manuals and datasheets.

Accessories

Advanced Illumination offers a variety of accessories designed to pair with our lighting and control products. Below you will find a table of accessories which are compatible with many configurations of the BL2 series.

Category	Accessory Image	Accessory Detail
Power Supply		<p>24 Volt DC Power Supply PN: PS24-TL</p> <p>This convenient power source is a universal AC input switching power supply with a regulated output DC current. The power supply comes with an LED Power Indicator, tinned leads marked Positive (+) and Negative (-) and 2 WAGO connectors for simplified assembly.</p> <p>For more information about our 24 Volt DC Power Supply, please visit this webpage.</p>
Dimmer		<p>Manual Dimming Accessory for the IC, I3, I3s and I4 PN: DCS-MP</p> <p>The DCS-MP is a 30-position potentiometer, detented for precision level control and provides repeatable dimming with cable inline controllers. Features include DIN-rail mountable, a flip up cover to prevent accidental adjustments, spring clamp wiring terminal for flying leads or an M12 connector for use with the IC, I3/I3S or I4 Inline Controllers.</p> <p>For more information about our Manual Dimming Accessory please visit this webpage.</p>

Accessories - Continued

Category	Accessory Image	Accessory Detail
Dimmer		<p>Manual Dimming Accessory for the IC PN: MP-ICS</p> <p>The MP-ICS is a dimmer which is designed for use on lights with the IC Inline Controller. This unit provides for 0 – 100% intensity control. It is NOT COMPATIBLE with LLI37, BLI38, LLI67, and BLI68 "IC" Lights or lights built with the "24v controller" option.</p> <p>For more information about our Manual Dimming Accessory, please visit this webpage.</p>
Extension Cable		<p>DCS-100E/103E Extension Cable, Single Light Power Cable - C1 Configuration PN: LC-XX-S</p> <p>This extension cable was designed for applications requiring power cables longer than the standard 2 meters provided with Ai lights. This single light cable features a single male and single female 7 pin locking connector (C1) and can be purchased in 3 - 15-meter lengths.</p> <p>For more information about our DCS-100E/103E Extension Cable, Single Output, please visit this webpage.</p>
Extension Cable		<p>DCS-100E/103E Extension Cable, Dual Light Power Cable - C1 Configuration PN: LC-XX-Y</p> <p>This extension cable was designed for applications requiring two identical lights to be powered through a single controller. These Y cables feature a single male and dual female 7 pin locking connectors (C1) and can be purchased in 3 - 15-meter lengths. See attached spec sheet for compatible light configuration.</p> <p>For more information about our DCS-100E/103E Extension Cable, Split Output, please visit this webpage.</p>
Extension Cable		<p>Pulsar 320E Extension Cable - C5 Configuration PN: LC-XX-S-C5</p> <p>This extension cable was designed for applications requiring power cables longer than the standard 2 meters provided with Ai lights. This single light cable features a single male and single female Pulsar 320 connector (C5) and can be purchased in 3 - 15 meter lengths.</p> <p>For more information about our Pulsar 320E Extension Cable, please visit this webpage.</p>
Adaptor Cable		<p>Cognex Gen2 Inline Controller Adaptor Cable PN: AD-I3-CGX2</p> <p>This cable adaptor is for connecting I3/I3S configured lights with Cognex Gen2 Cameras, and comes with a male to female M12 connectors.</p> <p>For more information about our Cognex Gen2 Inline Controller Adaptor Cable, please visit this webpage.</p>
Filters		<p>Camera Lens Band Pass Filters PN: BPXXX-YYY</p> <p>Eliminating all but a narrow band of light (+/- 40nm) centered on the specified wavelength, band pass filters are used to enhance colors, or to stop unwanted ambient light from reaching the camera. Filtering can replace existing shrouds, simplifying the physical set up of an inspection site. Ai offers 635nm and 660nm band pass filters to fit several different lens sizes.</p> <p>For more information about our Camera Lens Band Pass Filters, please visit this webpage.</p>

Additional Information

Warranty

Every Advanced illumination, Inc. (Ai) product is thoroughly inspected and tested before leaving the factory. Products are warranted to be free of defects in workmanship and materials for a period of FIVE YEARS from the original date of purchase. Should a defect develop during this period, customers may return the complete product, freight prepaid, to one of Ai's distributors or to the Ai factory. All product warranty returns require a Return Merchandise Authorization (RMA) number which is obtained from Customer Service. The RMA number must be clearly marked on the outside of the package. Ai will inspect the unit, and if a defect is found will, at our option, repair or replace the product without charge. Ai disclaims liability for any implied warranties, including implied warranties of "merchantability" and "fitness for a specific purpose." For products under warranty that have since been discontinued, Ai will make an effort to replace with equivalent parts; for circumstances that do not allow for equivalent replacement, Ai reserves the right to repair or replace these products with an updated version. Ai cannot be held responsible for the unauthorized or inappropriate use of its products. Any unauthorized repair or modifications will result in a voided warranty. No Liability for Consequential Damages: In no event shall Ai be liable for any consequential, special, incidental, or indirect damages of any kind arising from the sale or use of the products.

Compliance

Our lighting products are designed and tested to meet CE, RoHS, and IEC standards. As a global ISO 9001 certified company, we understand the importance of compliance and perform accelerated testing on every product before shipment. For more information on our compliance standards, please see our compliancy documentation here: <https://www.advancedillumination.com/services/compliance-statements/>

Electromagnetic Compatibility

This product was tested and complies with the regulatory requirements and limits for electromagnetic compatibility (EMC) as stated in the product specifications. These requirements and limits are designed to provide reasonable protection against harmful interference only when the product is operated in its intended industrial electromagnetic environment. To minimize the potential for electromagnetic interference or unacceptable performance degradation, install and use this product in strict accordance with the instructions in the product documentation.

Customer Service

For information on existing orders, or to make an order adjustment, contact us Monday through Friday 8:00 am to 5:00 pm ET or send an email to orders@advancedillumination.com.

Company Information

Advanced Illumination
440 State Garage Road, Rochester, VT 05767
Phone: +1 (802) 767 3830
Fax: +1 (802) 767 2636
Email: info@advancedillumination.com
Web: advancedillumination.com
© 2023 Advanced illumination Inc. All rights reserved